

## 15.2 Baskets and bread baskets

Paneras y cestas  
Paniers et corbeilles



Mt  
Metal

**P876001** Metal cone basket  
Cesta cono metal  
Panier métal cône

Mt  
Metal

NEW!



REF	cm	H cm	€/u	
P876001	13 x 13	18	5,95	1

**P876002** Metal cone basket 1 ramekin  
Cesta cono metal 1 ramekin  
Panier métal cône 1 ramequin

Mt  
Metal

NEW!

Ramekin not included  
Ramekin no incluido  
Ramequin non inclus

Ramekin compatible  
Compatible con ramekin  
Compatible ramequin  
P41007, P41013, P41014,  
P41016, P41017, P41019 y  
P41020



REF	cm	H cm	€/u	
P876002	19 x 13	18	6,95	1

**P876003** Metal cone basket 2 ramekins  
Cesta cono metal 2 ramekines  
Panier métal cône 2 ramequins

Mt  
Metal

NEW!

Ramekin not included  
Ramekin no incluido  
Ramequin non inclus

Ramekin compatible  
Compatible con ramekin  
Compatible ramequin  
P41007, P41013, P41014,  
P41016, P41017, P41019 y  
P41020

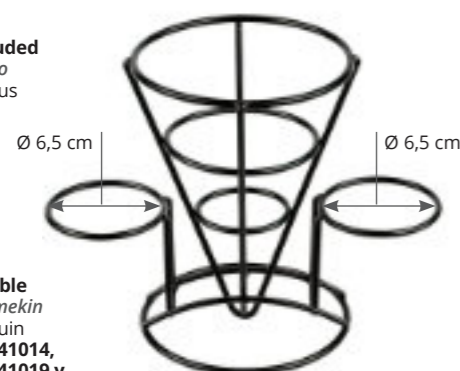

REF	cm	H cm	€/u	
P876003	25 x 13	18	7,95	1

See products on  
Ver productos en / Voir produits en page

P. 479

Ramekins  
Ramekins  
Ramequins



## Baskets and bread baskets 15.2

Paneras y cestas  
Paniers et corbeilles

Mt  
Metal

**P591001** Round metal basket  
Cesta metal redonda  
Panier métal rond

Mt  
Metal

NEW!



REF	Ø cm	H cm	€/u	
P591001	26,5	5	13,90	1

**P591002** Oval metal basket  
Cesta metal ovalada  
Panier métal ovale

Mt  
Metal

NEW!



REF	W x D x H cm	€/u	
P591002	22,5 x 15 x 4,5	12,25	1

**P591003** Rectangular metal basket  
Cesta metal rectangular  
Panier métal rectangulaire

Mt  
Metal

NEW!



REF	W x D x H cm	€/u	
P591003	23 x 10 x 4,5	11,85	1

**P591004** Rectangular metal basket  
Cesta metal rectangular  
Panier métal rectangulaire

Mt  
Metal

NEW!



REF	W x D x H cm	€/u	
P591004	23 x 17,5 x 4,5	13,90	1

**P591005** Round metal basket  
Cesta metal redonda  
Panier métal rond

Mt  
Metal

NEW!



REF	Ø cm	H cm	€/u	
P591005	20,5	13	14,95	1





# Baskets and breadbaskets 15.2

Paneras y cestas  
Paniers et corbeilles



**P100816** Brown bread basket  
*Cesta pan marrón*  
Corbeille à pain marron

Washable  
*Se puede lavar*  
Peuvent se laver



P100807

REF	W x D x H cm	€/u	
P100816	13,0 x 13,0 x 15	7,35	12
P100807	17,5 x 17,5 x 15	10,10	12
P100836	26,5 x 26,5 x 12	12,85	12

**P100808** Grey bread basket  
*Cesta pan gris*  
Corbeille à pain gris

Washable  
*Se puede lavar*  
Peuvent se laver



P100838

REF	W x D x H cm	€/u	
P100808	13,0 x 13,0 x 15	7,35	12
P100827	17,5 x 17,5 x 15	10,10	12
P100838	26,5 x 26,5 x 12	12,85	12

**P100817** Black bread basket  
*Cesta pan negra*  
Corbeille à pain noir

Washable  
*Se puede lavar*  
Peuvent se laver



P100826

REF	W x D x H cm	€/u	
P100817	13,0 x 13,0 x 15	7,35	12
P100826	17,5 x 17,5 x 15	10,10	12
P100837	26,5 x 26,5 x 12	12,85	12





# 15.2 Baskets and breadbaskets

Paneras y cestas  
Paniers et corbeilles



**P100740** Bread basket  
*Cesta pan*  
Corbeille à pain



P100740

REF	W x D x H cm	€/u	
P100740	29 x 29 x 47,5	65,10	12

**P100741** Bread basket  
*Cesta pan*  
Corbeille à pain



P100741

REF	W x D x H cm	€/u	
P100741	36 x 30 x 21 / 39	48,60	6
P100742	Ø 29 x 21 / 39	48,60	6



P100742

**P100780** Bread basket  
*Cesta pan*  
Corbeille à pain



P100780

REF	Ø cm	H cm	€/u	
P100780	35	35	37,25	12

**P10075** Slated bread basket  
*Cesta redonda inclinada*  
Corbeille ronde inclinée



REF	Ø cm	H cm	€/u	
P100754	36	10 / 20	24,10	6
P100755	40	13 / 23	30,95	6

**P10076** Slated rectangular basket  
*Cesta rectangular inclinada*  
Corbeille rectangulaire inclinée



REF	W x D x H cm	€/u	
P100760	40 x 28 x 6 / 10	30,45	12
P100761	58 x 38 x 8 / 12	49,25	6

**P10077** Two compartment rectangular basket  
*Cesta rectangular dos compartimentos*  
Corbeille rectangulaire deux compartiments



REF	W x D x H cm	€/u	
P100770	49 x 31 x 10 / 14,3	42,50	6

# Baskets and breadbaskets 15.2

Paneras y cestas  
Paniers et corbeilles



**P10079** Round basket  
*Cesta redonda*  
Corbeille ronde



REF	Ø cm	H cm	€/u	
P100792	24	5,5	9,45	60

**P10080** Round basket  
*Cesta redonda*  
Corbeille ronde



P100804

P100803

P100805

REF	Ø cm	H cm	€/u	
P100803	18	6,0	7,75	48
P100804	23	6,0	10,40	48
P100805	25	6,0	11,55	48

**P10081** Round basket  
*Cesta redonda*  
Corbeille ronde

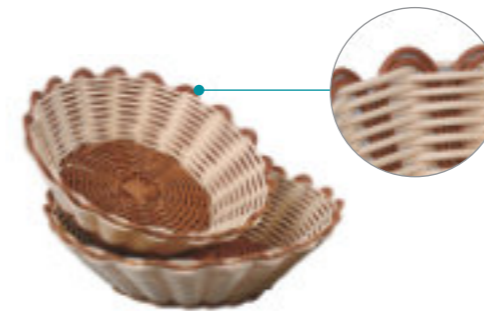

REF	Ø cm	H cm	€/u	
P100813	18,5	6,0	5,20	84
P100814	23,0	6,0	6,65	84

**P10082** Round basket  
*Cesta redonda*  
Corbeille ronde

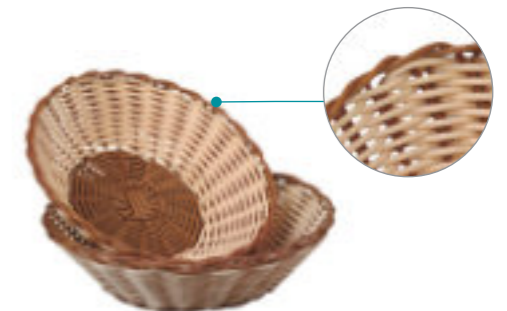

REF	Ø cm	H cm	€/u	
P100820	18,5	6,0	5,20	84
P100821	23,0	6,0	6,65	84

**P10090** Oval basket  
*Cesta oval*  
Corbeille ovale



REF	W x D x H cm	€/u	
P100900	30 x 23,5 x 7,5	10,40	36

# 15.2 Baskets and breadbaskets

Paneras y cestas  
Paniers et corbeilles



**P10084** Rectangular basket  
*Cesta rectangular*  
Corbeille rectangulaire



REF	W x D x H cm	€ / u	
P100840	21,5 x 18 x 8	9,45	84
P100841	26 x 20 x 7,5	8,45	48

**P10085** Rectangular basket  
*Cesta rectangular*  
Corbeille rectangulaire



REF	W x D x H cm	€ / u	
P100851	40 x 28,5 x 7	22,45	24

**P10086** Rectangular basket  
*Cesta rectangular*  
Corbeille rectangulaire



REF	W x D x H cm	€ / u	
P100860	37 x 27 x 7	19,85	24
P100861	46 x 34 x 7	26,90	24
P100862	46 x 34 x 12	32,30	12

**P10087** Rectangular basket  
*Cesta rectangular*  
Corbeille rectangulaire



REF	W x D x H cm	€ / u	
P100871	42 x 30 x 7	26,90	24

**P10088** Oval basket  
*Cesta oval*  
Corbeille ovale



REF	W x D x H cm	€ / u	
P100880	18 x 12 x 6,5	5,85	60
P100881	23,5 x 15 x 7	7,30	60
P100882	28 x 14,5 x 7,5	9,10	36

**P10089** Oval basket  
*Cesta oval*  
Corbeille ovale



REF	W x D x H cm	€ / u	
P100890	19 x 13 x 7	6,90	48
P100891	25 x 15 x 8	9,45	60
P100892	29 x 19 x 10	10,65	60

# Baskets and breadbaskets 15.2

Paneras y cestas  
Paniers et corbeilles



**P10093** Cutlery dispenser  
*Cesta para cubiertos*  
Corbeille à couverts



REF	W x D x H cm	€ / u	
P100931	30 x 11 x 7	9,50	96
P100932	30 x 11 x 7	9,50	96

**P10094** Cutlery dispenser  
*Cesta para cubiertos*  
Corbeille à couverts



REF	Ø cm	H cm	€ / u	
P100940	13	14	7,75	36

**P10095** Rectangular buffet basket  
*Cesta buffet rectangular*  
Corbeille rectangulaire buffet



GN 1/1



\* Lid  
Tapa  
Couvercle

REF	cm	Total H cm	Base H cm	€ / u	
P100950	53 x 31,5	26,0	8,5	38,00	12
P100951	53 x 31,5	26,0	8,5	38,00	12
P100955*				70,60	6

**P10096** Round buffet basket  
*Cesta buffet redonda*  
Corbeille ronde buffet



\* Lid  
Tapa  
Couvercle

REF	Ø cm	H cm	€ / u	
P100960	40	30	24,70	24
P100965*			37,35	6



## 15.2 Place mats

Manteles individuales  
Sets de table

PVC

Place mats made of PVC + polyester.  
To clean please use a damp sponge or cloth.

Manteles individuales fabricados en PVC + poliéster. Para su limpieza se aconseja usar una esponja o trapo húmedo.

Sets de table fabriqués en PVC + polyester.  
Nettoyer à l'aide d'une éponge ou un chiffon humide.

**P92605** DECO place mats  
Manteles individuales DECO  
Sets de table DECO

PVC

REF	cm	€/ PACK 6u	
P926051	45 x 30	17,90	20
P926052	45 x 30	17,90	20
P926053	45 x 30	17,90	20

Price / Precio / Prix : Pack 6 u.

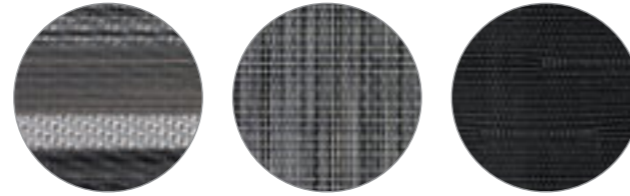

**Brown&Black Lines**  
Líneas marrones-negras  
Lignes marrons et noirs  
P926051

**Brown&Black**  
Marrón-negro  
Marron et noir  
P926052

**Black**  
Negro  
Noir  
P926053

**P9260** Place mat fine band  
Mantel individual trama fina  
Set de table maille fine

REF	cm	€/ u	
P926006	45 x 30	17,90	20
P926007	45 x 30	17,90	20
P926008	45 x 30	17,90	20
P926009	45 x 30	17,90	20

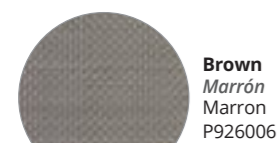

**Brown**  
Marrón  
Marron  
P926006



**Coffee**  
Café  
Café  
P926007



**Black&White**  
Negro-Blanco  
Noir et blanc  
P926008

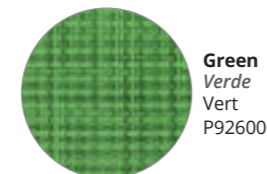

**Green**  
Verde  
Vert  
P926009

**P926** Place mat wide band  
Mantel individual trama gruesa  
Set de table maille épaisse

REF	cm	€/ u	
P926002	45 x 30	18,30	20
P926003	45 x 30	18,30	20
P926004	45 x 30	18,30	20
P926005	45 x 30	18,30	20
P926010	45 x 30	17,90	20
P926011	45 x 30	17,90	20
P926012	45 x 30	17,90	20



**Orange**  
Naranja  
P926002

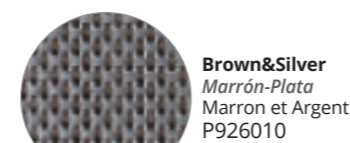

**Brown&Silver**  
Marrón-Plata  
Marron et Argent  
P926010



**Burgundy**  
Burdeos  
Bordeaux  
P926003



**Brown&Gold**  
Marrón-Dorado  
Marron et Doré  
P926011

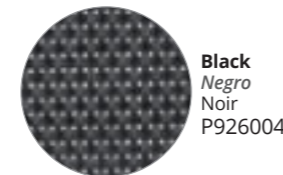

**Black**  
Negro  
Noir  
P926004



**Silver**  
Plateado  
Argent  
P926012

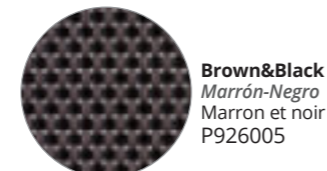

**Brown&Black**  
Marrón-Negro  
Marron et noir  
P926005

## Flared sauce cups 15.3

Salseras  
Saucières

**P4100** Ramekin / Sauce container  
Recipiente para salsas  
Récipient pour sauces

SS  
Stainless steel

NEW!



Price / Precio / Prix : Pack 12 u.

REF	Ø cm	H cm	ml	€/ PACK 12u	
P41005	6,2	2,75	45	5,90	12
P41006	5,8	4,50	75	6,65	12
P41007	7,4	5,20	135	13,10	12

**P4101** Ramekin / Sauce container  
Recipiente para salsas  
Récipient pour sauces

PET

NEW!



Price / Precio / Prix : Pack 12 u.

REF		Ø cm	H cm	ml	€/ PACK 12u	
P41012	white	6,0	3,5	45	8,85	12
P41013	blanco	7,0	3,5	60	10,90	12
P41014	blanc	7,5	4,0	90	12,95	12
P41015	black	6,0	3,5	45	8,85	12
P41016	negro	7,0	3,5	60	10,90	12
P41017	noir	7,5	4,0	90	12,95	12
P41018	transparent	6,0	3,5	45	8,85	12
P41019	transparente	7,0	3,5	60	10,90	12
P41020	transparent	7,5	4,0	90	12,95	12

**P623** Snack bowl set or sauce bowl set  
Portasalados o portasalzas  
Ensemble bols pour snacks ou sauces

SS  
Stainless steel



REF	UNI.	Ø cm/u	ml/u	€/ u	
P623003	3	9	200	49,45	25

**P333** Gravy boat  
Salsera  
Saucière

SS  
Stainless steel



REF	L	€/ u	
P333010	0,10	6,45	72
P333020	0,20	10,35	36
P333035	0,35	11,80	24

# 15.3 Table accessories

Complementos de mesa  
Accessoires de table



**P638003** Table caddy. 3 Compartments  
Caddy de mesa. 3 Compartimentos  
Caddy de table. 3 compartiments

Galvanised steel  
Acero galvanizado  
Acier galvanisé

Wooden handle  
Asa de madera  
Manche en bois



dishwasher



REF	W x D x H cm	€/u	📦
P638003	26 x 10 x 12	16,90	6

**P638004** Table caddy. 4 Compartments  
Caddy de mesa. 4 Compartimentos  
Caddy de table. 4 compartiments

Galvanised steel  
Acero galvanizado  
Acier galvanisé

Wooden handle  
Asa de madera  
Manche en bois



dishwasher



REF	W x D x H cm	€/u	📦
P638004	26 x 18 x 12	22,30	6

# Table accessories 15.3

Complementos de mesa  
Accessoires de table

**P96700** Pepper mill-salt mill. Wooden  
Molinillos pimienta y sal. Madera  
Moulin à poivre et sel. Bois



REF	H cm	€/u	📦
P967007	12,5	13,05	1
P967008	15,0	15,00	1
P967009	19,5	17,60	1

**P967** Pepper mill-salt mill. Acrylic  
Molinillos pimienta y sal. Acrílico  
Moulin à poivre et sel. Acrylique



REF	Type / Tipo	H cm	€/u	📦
P967001	A	15,5	14,90	48
P967002	A	20,0	16,10	48
P967003	A	23,0	17,15	48
P967004	B	15,5	11,15	48
P967005	B	20,0	12,45	48
P967006	B	23,0	13,60	48

**P630** Number card holder  
Soporte para número "banquete"  
Support numéro "banquet"



REF	H cm	€/u	📦
P630010	10	11,15	50
P630020	20	12,45	50
P630030	30	14,10	50
P630040	40	17,30	50

**P632** Table number  
Número de mesa  
Numéro de table

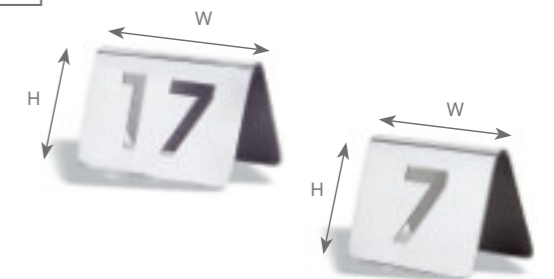

N. 1 - N. 30 \*\* number with 2 digits. \* number with 1 digit.  
\*\* número de 2 dígitos. \* número de 1 dígito.  
\*\* numero de 2 chiffres. \* numero d'un seul chiffre.

REF	W x H cm	€/u	📦
P63200 + NUM*	6,4 x 5,6	3,00	1
P6320 + NUM**	7,6 x 5,6	3,00	1

**P633** "Reserved" table sign  
Placa "Reservado"  
Plaque "reserve"



REF	Text	W x H cm	€/u	📦
P633000	RESERVADO	10 x 5	4,60	300
P633002	RESERVED	10 x 5	4,60	200
P633003	RESERVE	10 x 5	4,60	310

**P634** "Non-smoking" sign  
Placa "Prohibido fumar"  
Plaque "Défense de fumer"



REF	W x H cm	€/u	📦
P634000	7,6 x 5,6	3,95	100